

## **DOMINO 300**

Lagana okvirna oplata za stanogradnju i niskogradnju



Izdanje 07 | 2013

**PERI GmbH**  
**Formwork Scaffolding Engineering**

Rudolf-Diesel-Strasse 19  
89264 Weissenhorn  
Germany  
info@peri.com  
www.peri.com

**Važne upute**

Prilikom primjene naših proizvoda u pojedinim zemljama treba voditi računa o aktualnim verzijama važećih zakona i sigurnosnih propisa.

Slike u ovoj brošuri aktualne su snimke gradilišta. Stoga se posebice sigurnosni detalji i detalji sidrenja ne mogu uvijek smatrati konačnim. Ti detalji podliježu izvođačevoj procjeni opasnosti.

Također se primjenjuju računalne grafike koje se trebaju interpretirati kao prikazi sistema. Radi boljeg razumijevanja prikazi nekih detalja dijelom su nepotpuni. Unatoč tome sigurnosni uređaji koji nisu prikazani u ovom opisu detalja moraju biti na raspolaganju.

Prikazani sistemi ili artikli eventualno nisu raspoloživi u svakoj državi.

Nužno je voditi računa o sigurnosnim uputama i podacima o opterećenju.  
Sve izmjene i odstupanja iziskuju poseban statički dokaz.

Tehničke izmjene u cilju poboljšanja uzimaju se s rezervom.  
Zadržano pravo na zabune, greške u pisanju i tiskarske greške.

# Sadržaj

## **DOMINO**

- 2 Lagana okvirna oplata za montažu do 3,00 m visine

## **Izvedbeni detalji**

- 4 Kutovi, T-zidovi i izjednačavanja dužine
- 6 DOMINO pribor
- 8 Pregled programa

# PERI DOMINO

## Lagana okvirna oplata za montažu do 3,00 m visine

**PERI DOMINO lagana je okvirna oplata za stanogradnju i niskogradnju s elementima od čeličnih okvira. Posebno je razvijena za montažu zidova podruma do 3,00 m visine, temelje i okna.**

### **Samo 4 širine elemenata**

Samo 4 širine elemenata (1,00 m, 0,75 m, 0,50 m i 0,25 m) omogućuju montažu svakog tlocrta. Element 0,75 m raspoloživ je i kao višenamjenski element.

### **DOMINO spojnica DRS**

Spojnica DRS služi za spajanje elemenata okvirne oplata. U jednoj radnoj fazi osigurava spoj kojim se elementi povezuju, izravnavaju i učvršćuju.

Spojnica DRS omogućuje primjenu prilagodne gredice do 12 cm debljine.

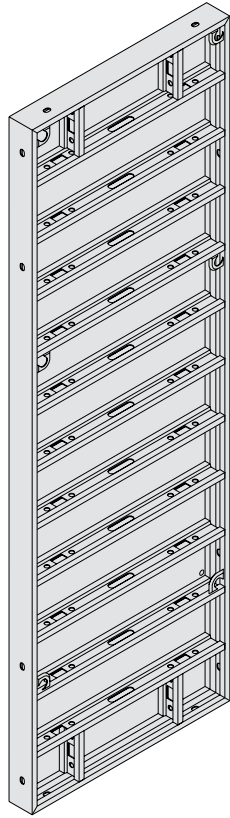

300 x 100

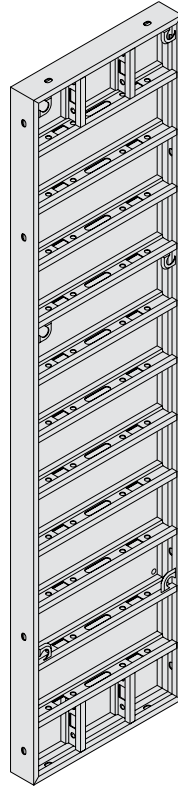

300 x 75

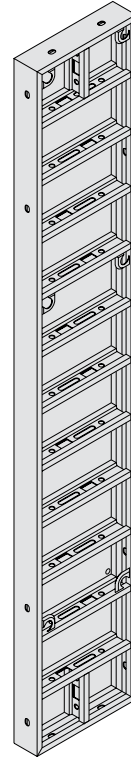

300 x 50

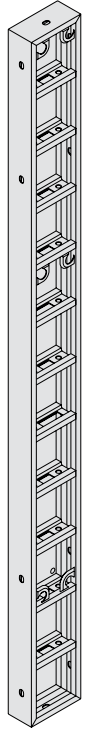

300 x 25

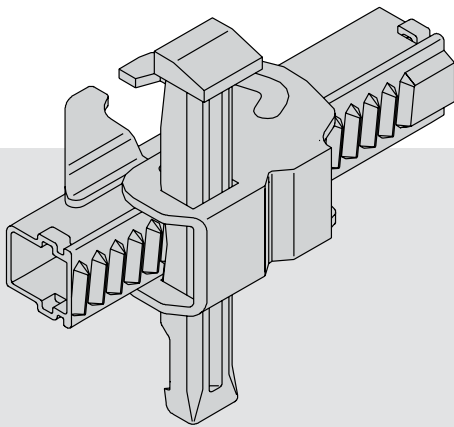

DOMINO spojnica DRS na normalnom spoju elemenata ...



... ili kod prilagodnih gredica do 12 cm debljine.

### Manje sidara

DOMINO 300 zahtijeva samo 2 sidra kod visina betoniranja do 3,0 m. To znači 1,5 m<sup>2</sup> zidne površine po sidru.

### Dopušteni pritisak svježeg betona

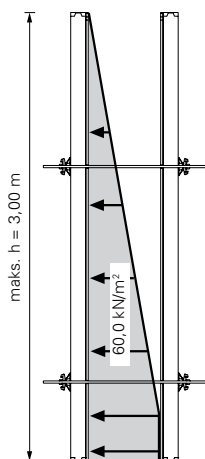

#### Visine betoniranja ≤ 3,0 m.

2 sidra maks. 60 kN/m<sup>2</sup>,  
DIN 18202, tab. 3, redak 7.

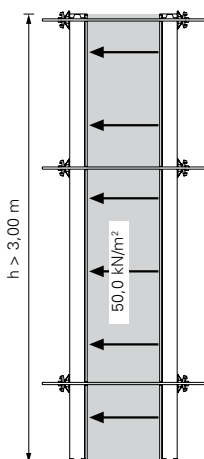

#### Visine betoniranja > 3,0 m.

3 sidra maks. 50 kN/m<sup>2</sup>,  
DIN 18202, tab. 3, redak 6.

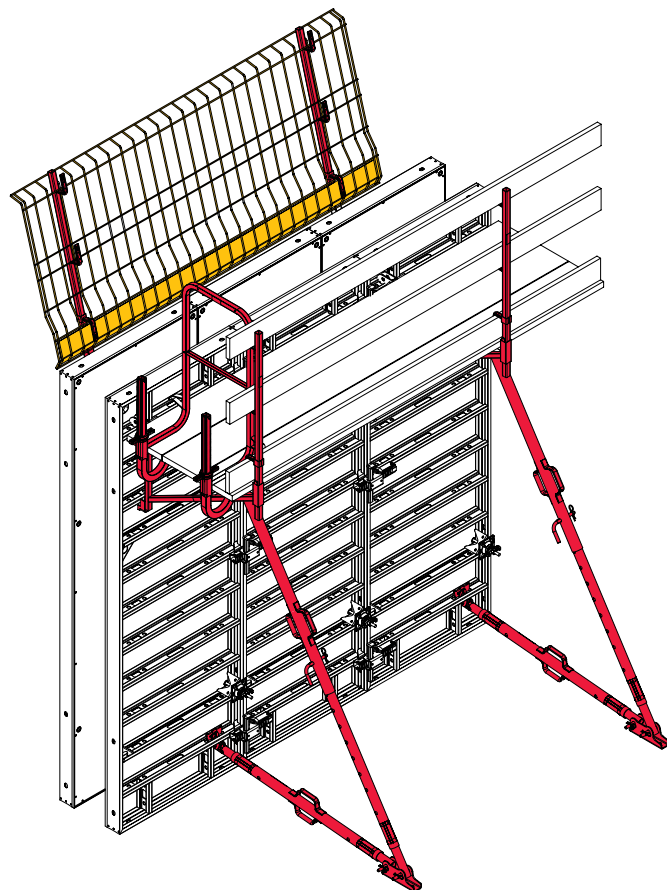

### DOMINO klinasta spojnica DKS

Standardna komponenta za normalan spoj elemenata u području temelja.



Klinasta spojnica DKS za standardne spojeve elemenata bez izlaganja velikom opterećenju.

# PERI DOMINO izvedbeni detalji

## Kutovi, T-zidovi i izjednačavanja dužine

### Kutovi

Element širine 50 cm i vanjski kutni element DAW formiraju vanjski kut. U kombinaciji s elementom za izjednačavanje debljine zida DWD 5 moguće su debljine zidova od 15 cm do 35 cm u rasteru od 5 cm.

#### Temeljna pravila za kutove:

Vanjska oplata: element D 300 x 50  
kutni element DAW  
Unutarnja oplata: unut. čelič. kut DISE  
Prilagodba debljini zida elementom za izjednačavanje DWD ili rubnom gredicom.  
Alternativa: zglobni kutni element DGE s 2 kutna elementa za učvršćivanje 90°.

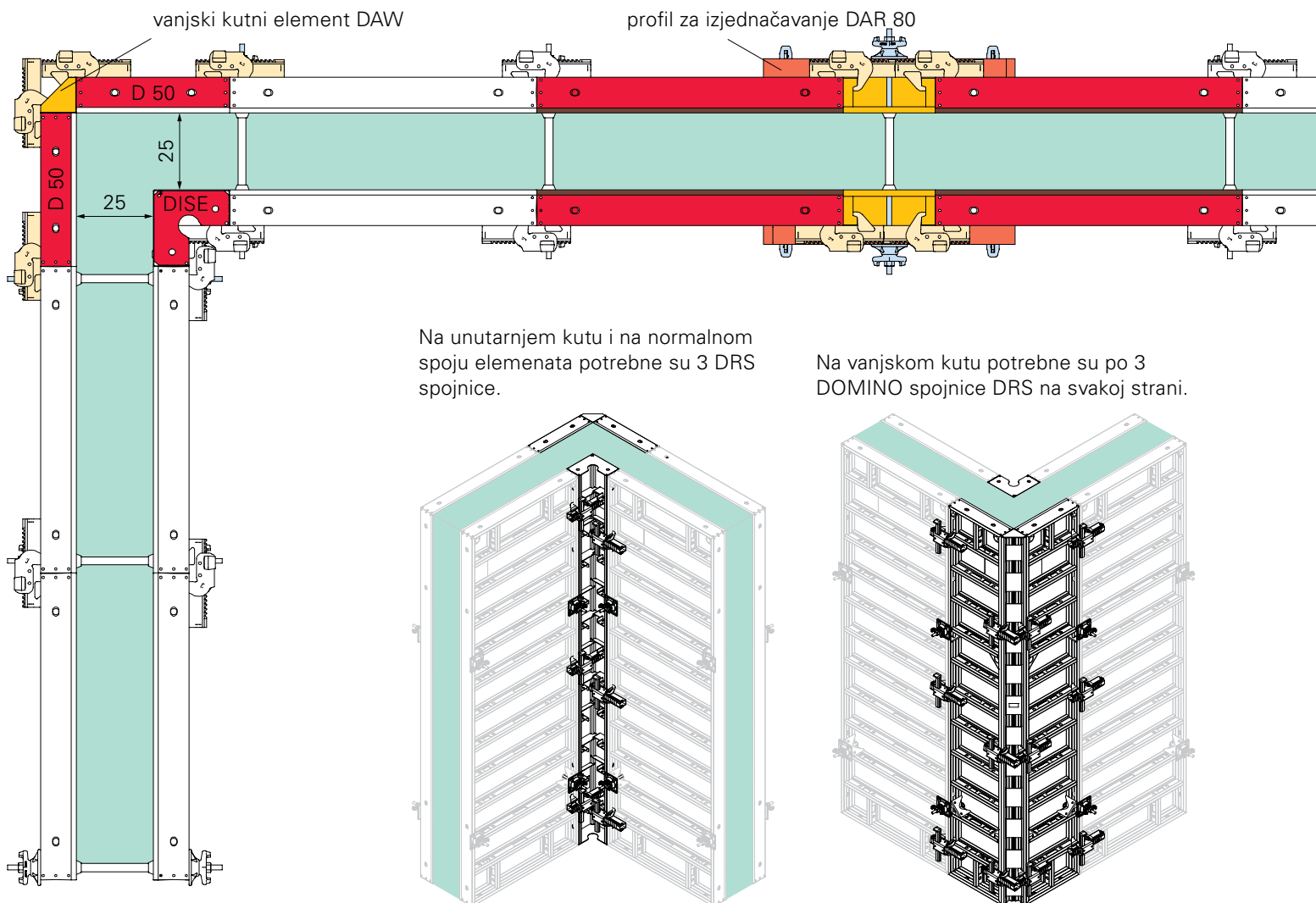
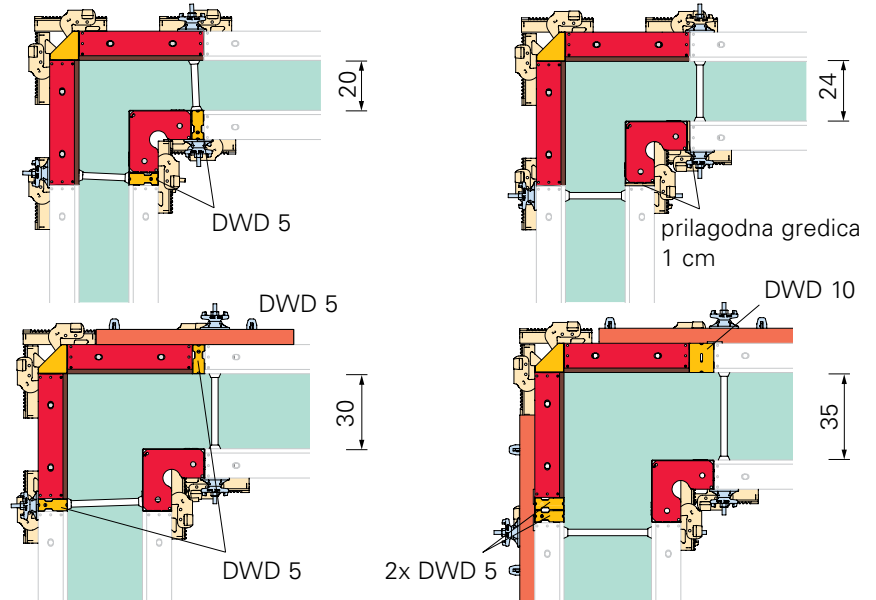

Na unutarnjem kutu i na normalnom spoju elemenata potrebne su 3 DRS spojnice.

Na vanjskom kutu potrebne su po 3 DOMINO spojnice DRS na svakoj strani.

## T-zidovi

Element širine 75 cm i zglobni kutni elementi formiraju T-zid. U kombinaciji s elementom za izjednačavanje debljine zida DWD 5 moguće su debljine zidova od 15 cm do 35 cm u rasteru od 5 cm.

Temeljna pravila za T-zidove:

**Vanjska oplata:** element D 300 x 75

**Unutarnja oplata:** zglobni kut DGE

Prilagodba debljini zida elementom za izjednačavanje DWD ili rubnom gredicom.

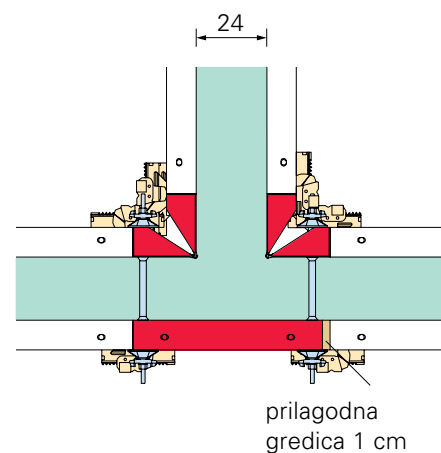
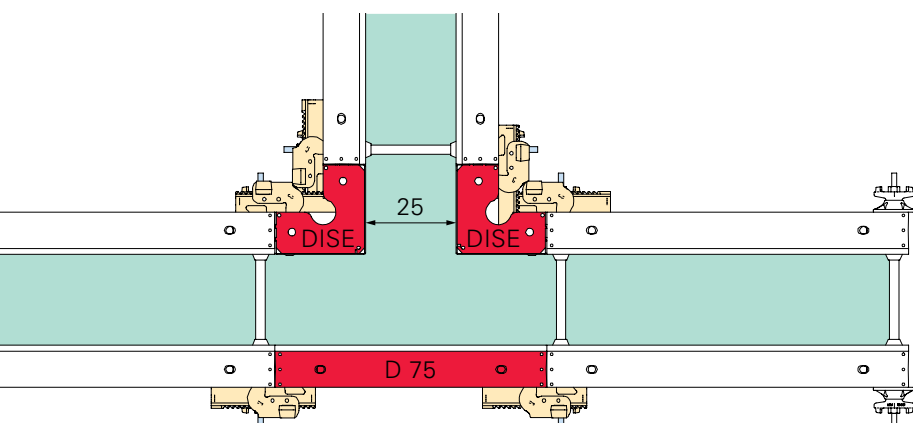
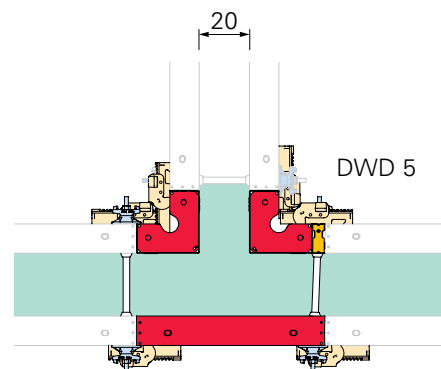

## Izjednačavanje dužine

Do 30 cm osloncem prilagodne ploče i profilom za izjednačavanje DAR 80.

Do 12 cm DOMINO spojnicom DRS i prilagodnom gredicom.

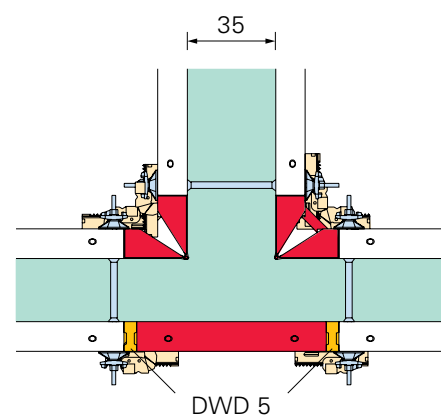
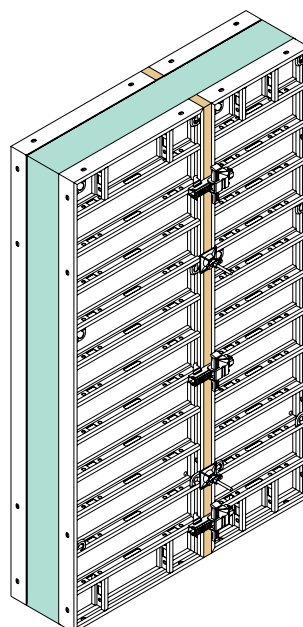
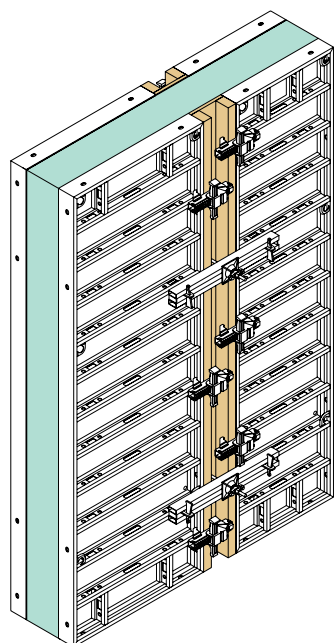
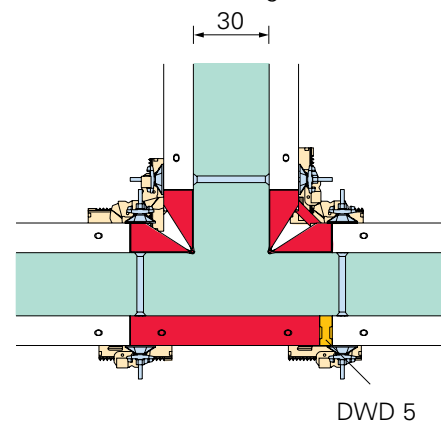

# DOMINO pribor

## Za brzu i jednostavnu montažu ...

**Svi poprečni profili DOMINO elemenata imaju priključne otvore za pribor. Ti detalji omogućuju brzu i jednostavnu montažu.**

### DOMINO kutija za slaganje

Olakšava transport dizalicom i slaganje na gradilištu. Složeni elementi mogu se premještati viličarom. 8 elemenata jedne veličine slaže se brzo i sigurno.

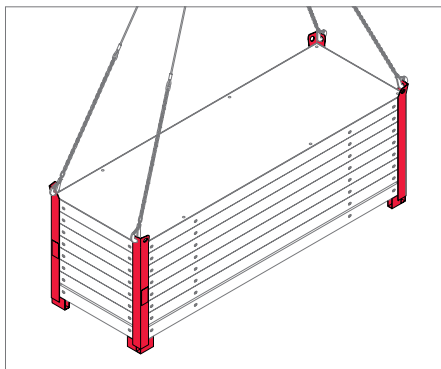

Transport složenih elemenata pomoću DOMINO kutije sa slaganje.

### Priključak kosnika DRA

Za priključak kosnika i stabilizatora na horizontalne i vertikalne profile.

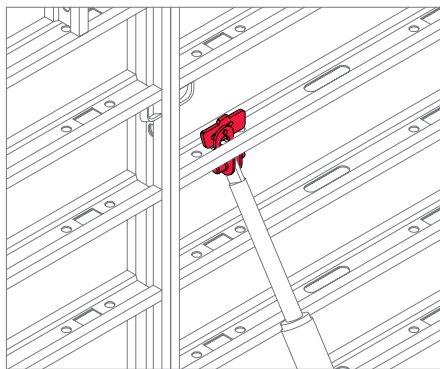

Klinasta spojnica koje se ne može izgubiti jako pojednostavljuje montažu.

### DOMINO skela DG 85

Za skelu za betoniranje širine 85 cm. Maksimalan razmak između konzola 2,00 m pri 150 kg/m<sup>2</sup> korisne težine.

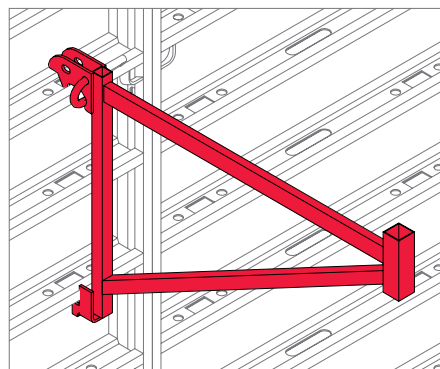

Jednostavan ovjes i osiguravanje svornjicama.

### DOMINO kuka za premještanje

Za premještanje stojećih DOMINO elemenata odn. jedinica elemenata. Kontinuirano se moraju primjenjivati 2 komada po transportnoj jedinici, nosivost po kuki iznosi 500 kg.

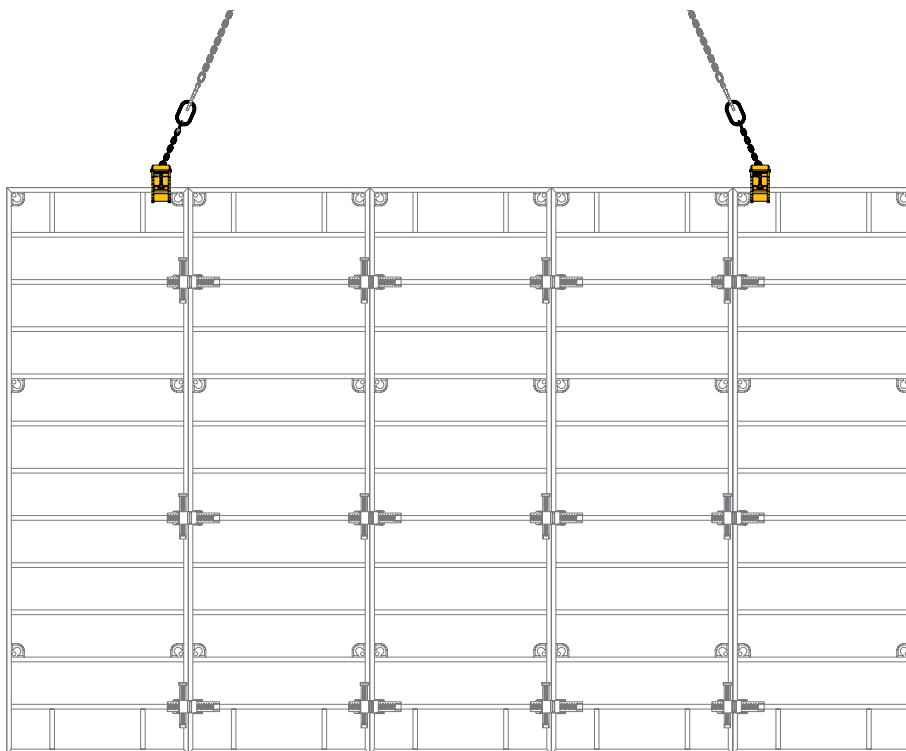
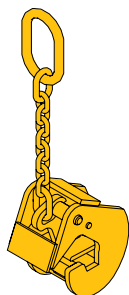



# ... i za temelje

Svi DOMINO elementi prikladni su za montažu temelja.

Posebnu prednost čine elementi s uvučenim sidrenim pozicijama. Oni omogućuju jednostavno sidrenje u području tla.

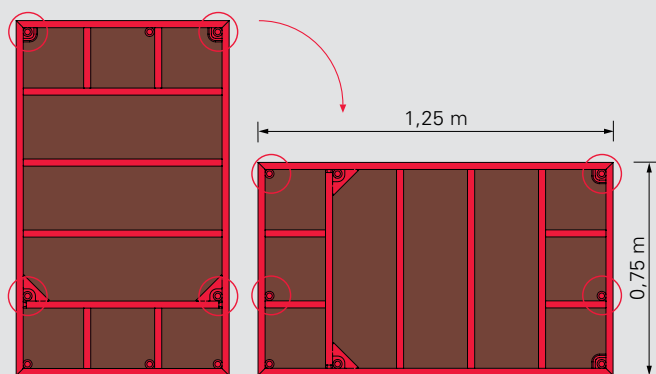

DOMINO elementi  $h = 1,25\text{ m}$  i  $h = 1,50\text{ m}$  imaju uvučene sidrene pozicije i mogu se bez problema primjenjivati i u ležećem položaju.

## Trakasti i pojedinačni temelji izvode se stezačem perforirane trake i držačem sidra.

DOMINO stezač perforirane trake za jednostavnu montažu temelja zamjenjuje donju poziciju sidra i štedi na radnom prostoru, a time i na zemljanim radovima.

Stezanje se precizno izvodi preko samočišćećeg šestobridnog vretena.

Prilikom primjene držača sidra za gornji položaj sidra DOMINO elementi ne moraju stajati točno jedan nasuprot drugom. Sidrenje je moguće na svakoj poziciji elementa.

Stezač perforirane trake

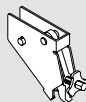

Držač sidra



Perforirana traka

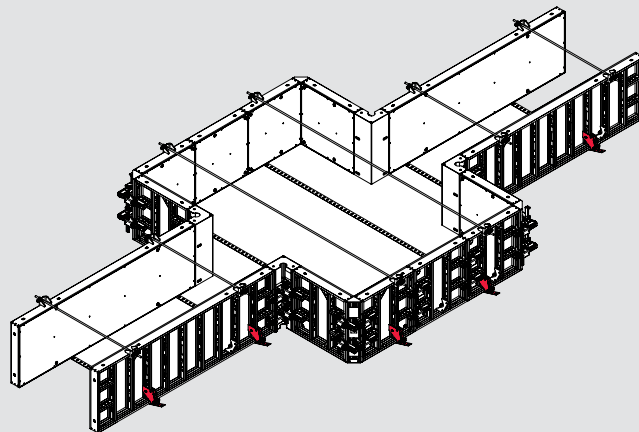
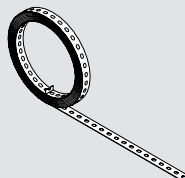

Bez obzira radi li se o pojedinačnim ili trakastim temeljima, DOMINO elementi i pribor omogućuju jednostavan rad.

# DOMINO 300 okvirna oplata

br. art.	težina kg
066000	102,000

## Element D 300 x 100

Čelični element s oplatom pločom 15 mm.

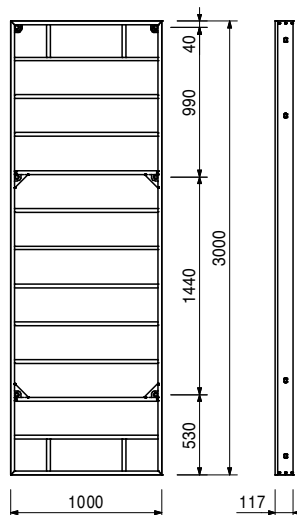
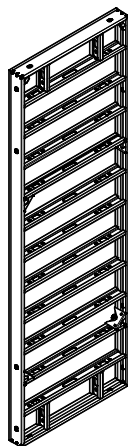

066002	83,100
--------	--------

## Element D 300 x 75

Čelični element s oplatom pločom 15 mm.

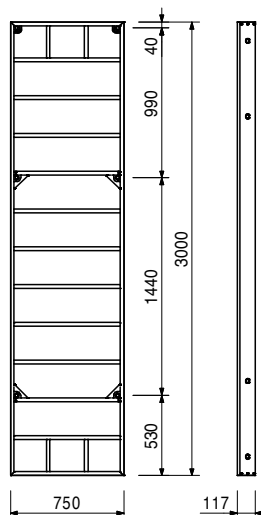
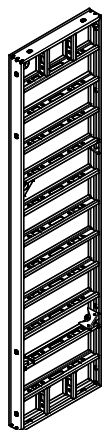

066005	63,300
--------	--------

## Element D 300 x 50

Čelični element s oplatom pločom 15 mm.

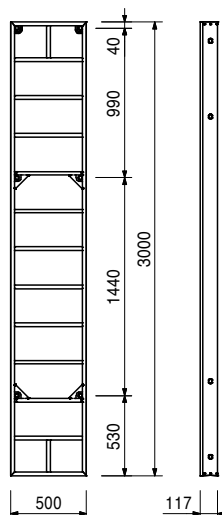
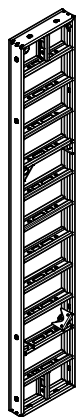

# DOMINO 300 okvirna oplata



br. art.	težina kg
066006	43,700

**Element D 300 x 25**  
Čelični element s oplatnom pločom 15 mm.

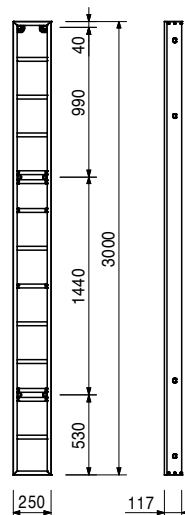

066004	90,600
--------	--------

**Višenamjenski element DM 300 x 75**  
Čelični element s oplatnom pločom 15 mm.  
Za kose kutove, zidne priključke itd.

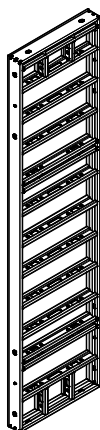

**Komplet s**  
69 kom. 030290 čepovi Ø 20 mm

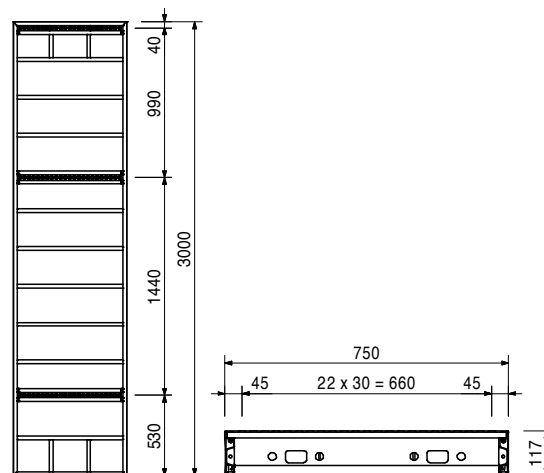

126298	80,400
--------	--------

**Unutarnji čelični kutni element DISE 300**

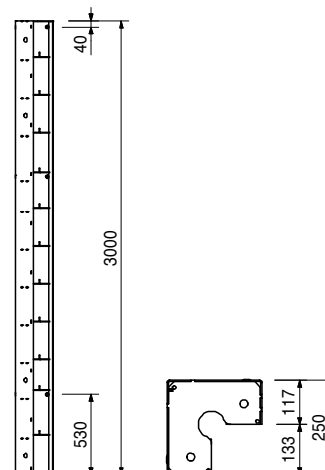
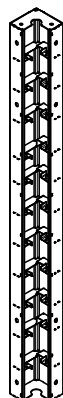

br. art.	težina kg
066009	47,800

## Zglobni kutni element DGE 300

Aluminijski element s aluminijskom oplatnom pločom. Za kose kutove od 75° primjenjuje se izvana i iznutra.

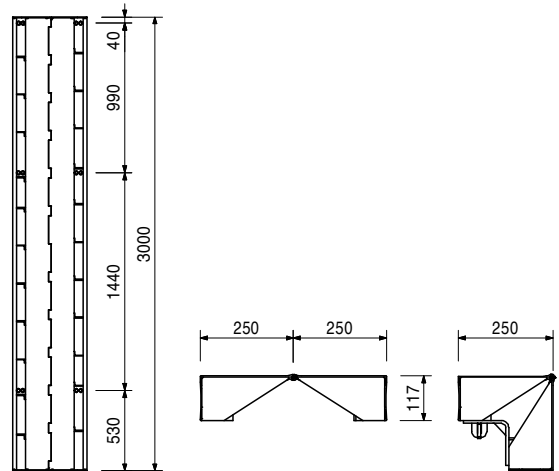
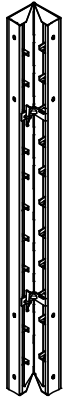

066010	9,360
--------	-------

## Element za izjednač. debljine zida DWD 300 x 5

Za prilagodbu debljinama zida u kutnom području DOMINO sistema.

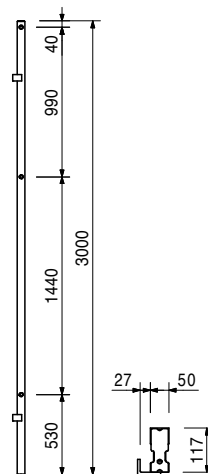

066008	12,500
--------	--------

## Vanjski kutni element DAW 300

Za spoj elemenata na vanjskim kutovima od 90°.

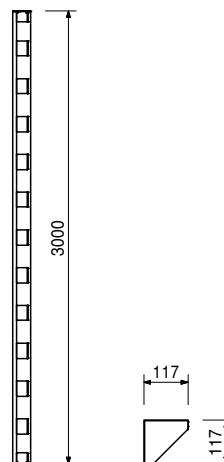

# DOMINO 300 okvirna oplata

br. art.	težina kg
066011	5,000
066012	4,700

**Oslonci prilagodne ploče DPA 300**  
**Oslonac prilagodne ploče DPA 300**  
**Oslonac prilagodne ploče DPA 300/27**  
Za izjednačavanje oplatnom pločom debljine 21 odnosno 27 mm.

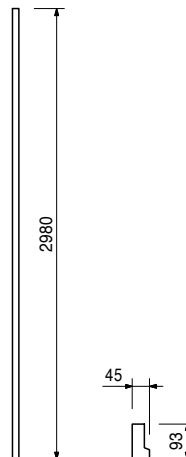

111617	167,000
--------	---------

**Element okna DSE 300**  
Element za premještanje kompletne unutarnje oplata okna.

**Tehnički podaci**  
Dopuštena nosivost točke preuzimanja opterećenja 2,0 t.

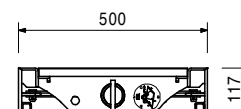
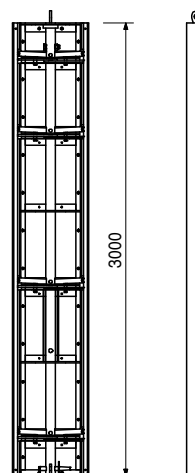

111665	4,360
--------	-------

Pribor  
**Vreteno elementa okna DSE**

# DOMINO 300 okvirna oplata



br. art.	težina kg
066087	2,550

**Čeona trobridna letvica DSD 300**  
 Za DOMINO oplata stupa i vanjske kutove.

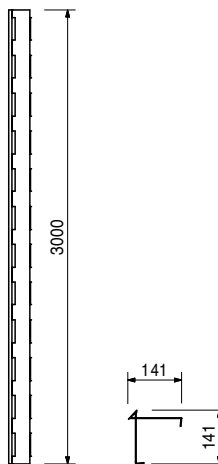

066013	55,400
066014	52,000
066015	48,300
066016	39,000

**Elementi stupa DS 300**  
**Element stupa DS 300 x 40**  
**Element stupa DS 300 x 35**  
**Element stupa DS 300 x 30**  
**Element stupa DS 300 x 20**

**B**

400  
 350  
 300  
 200

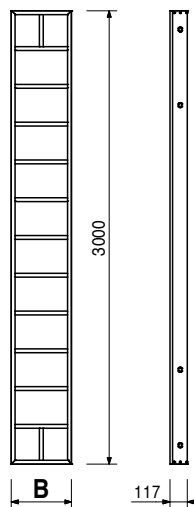

# DOMINO 300 okvirna oplata

br. art.	težina kg
101927	16,200
108855	17,900

**Čeoni elementi DOMINO AT 250**  
**Čeoni element DOMINO AT 250 x 3**  
**Čeoni element DOMINO AT 250 x 5**

Vanjski dio za čeone oplate DOMINO sistema.

### Uputa

Pokrivanje betonom oko 30 odn. 50 mm.

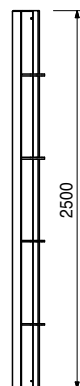

**AT 250 x 3**

**AT 250 x 5**

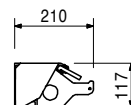

101928	27,100
101929	31,200
101930	36,000
101931	39,700

**Čeoni elementi DOMINO MTF 250**  
**Čeoni element DOMINO MTF 250 x 20**  
**Čeoni element DOMINO MTF 250 x 24/25**  
**Čeoni element DOMINO MTF 250 x 30**  
**Čeoni element DOMINO MTF 250 x 35/36**

Središnji dio s osloncem dilatacijske trake za čeone oplate DOMINO sistema.

### B

118  
 158  
 218  
 268

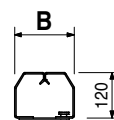
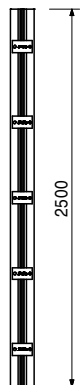

124498	56,500
--------	--------

### Element D 150 x 100

Čelični element s oplatnom pločom 15 mm.

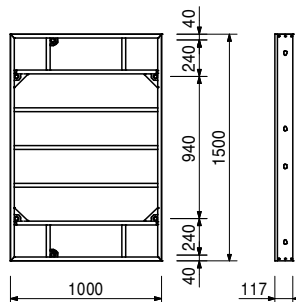
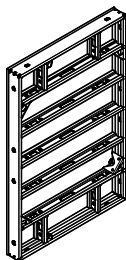

# DOMINO 300 okvirna oplata

br. art.	težina kg
124504	46,100

## Element D 150 x 75

Čelični element s oplatnom pločom 15 mm.

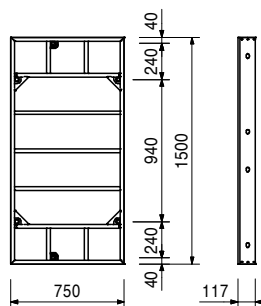
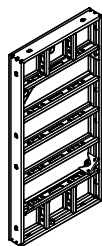

124510	34,200
--------	--------

## Element D 150 x 50

Čelični element s oplatnom pločom 15 mm.

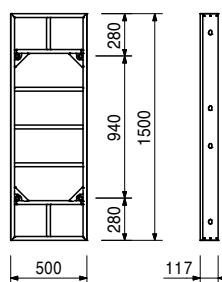

124517	26,800
--------	--------

## Element D 150 x 35

Čelični element s oplatnom pločom 15 mm.

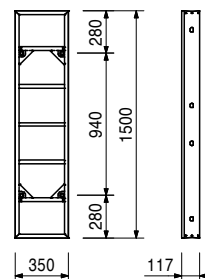

124523	22,700
--------	--------

## Element D 150 x 25

Čelični element s oplatnom pločom 15 mm.

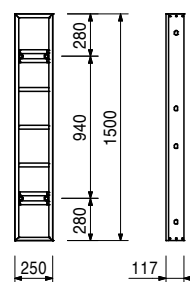



# DOMINO 300 okvirna oplata



br. art.	težina kg
124538	51,300

**Višenamjenski element DM 150 x 75**  
 Čelični element s oplatnom pločom 15 mm.  
 Za kose kutove, zidne priključke itd.

**Komplet s**  
 46 kom. 030290 čepovi Ø 20 mm

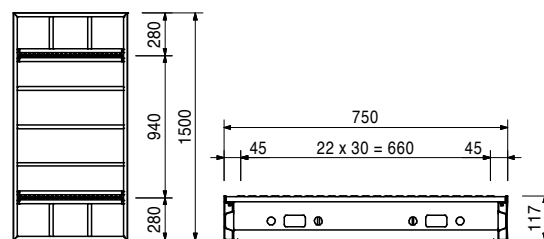
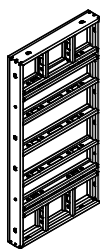

126286	40,800
--------	--------

**Unutarnji čelični kutni element DISE 150**  
 Za unutarnje kutove od 90°.

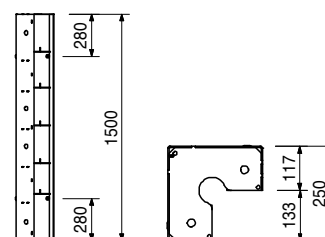
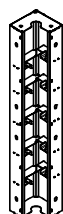

124605	23,700
--------	--------

**Zglobni kutni element DGE 150**  
 Aluminijski element s aluminijskom oplatnom pločom. Za kose kutove od 75° primjenjuje se izvana i iznutra.

**Komplet s**  
 1 kom. 066100 kutni elem. za učvršć. DEA 90°

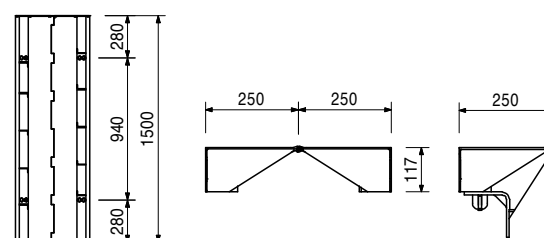

124608	6,490
--------	-------

**Vanjski kutni element DAW 150**  
 Za spoj elemenata na vanjskim kutovima od 90°.

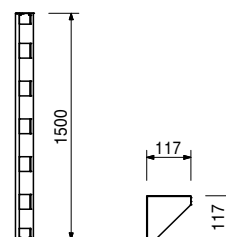

# DOMINO 300 okvirna oplata

br. art.	težina kg
125944	4,790
125660	7,060

**Elementi za izjednačavanje debljine zida DWD**  
**Elem. za izjednač. debljine zida DWD 150/5**  
**Elem. za izjednač. debljine zida DWD 150/10**  
 Za prilagodbu debljinama zida.

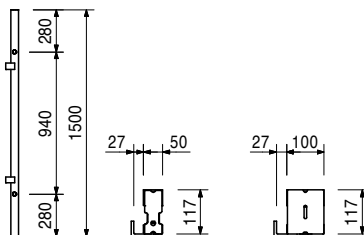

124577	2,480
--------	-------

**Oslonac prilagodne ploče DPA 150**  
 Za izjednačavanje prilagodnom pločom 21 mm.

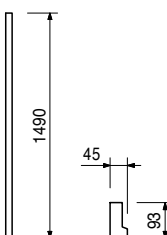

066040	47,300
--------	--------

**Element D 125 x 100**  
 Čelični element s oplatnom pločom 15 mm.

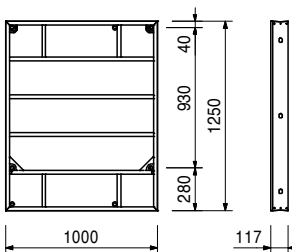
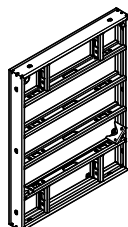

066041	38,700
--------	--------

**Element D 125 x 75**  
 Čelični element s oplatnom pločom 15 mm.

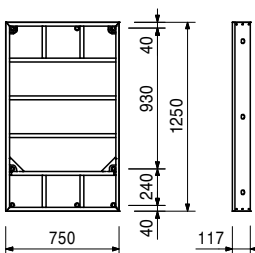
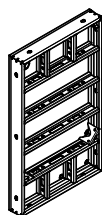

# DOMINO 300 okvirna oplata

br. art.	težina kg
066043	28,600

**Element D 125 x 50**  
Čelični element s oplatnom pločom 15 mm.

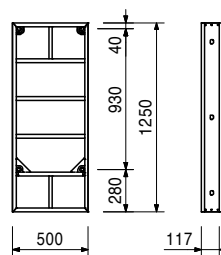

125494	22,400
--------	--------

**Element D 125 x 35**  
Čelični element s oplatnom pločom 15 mm.

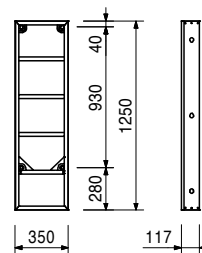

066044	18,600
--------	--------

**Element D 125 x 25**  
Čelični element s oplatnom pločom 15 mm.

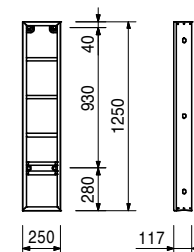

066050	31,000
--------	--------

**Element DA 125 x 100**  
Aluminijski element s oplatnom pločom 15 mm.

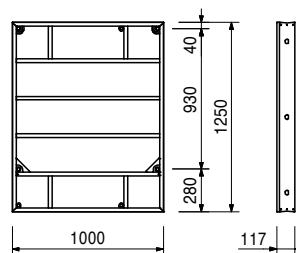
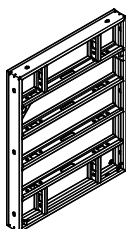

br. art.	težina kg
066051	24,800

## Element DA 125 x 75

Aluminijski element s oplatnom pločom 15 mm.

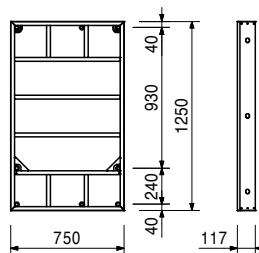
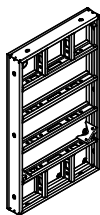

066042	43,700
066052	27,300

## Višenamjenski elementi DM/DMA 125

### Višenamjenski element DM 125 x 75

### Višenamjenski element DMA 125 x 75

Čelični/aluminijski element s oplatnom pločom 15 mm. Za kose kutove, zidne priključke itd.

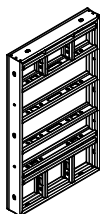

## Komplet s

46 kom. 030290 čepovi Ø 20 mm

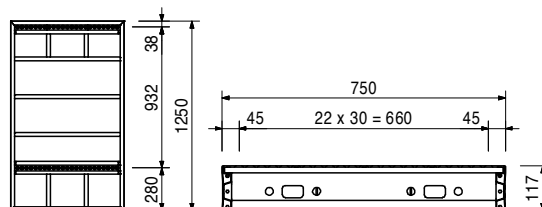

126280	34,200
--------	--------

## Unutarnji čelični kutni element DISE 125

Za unutarnje kutove od 90°.

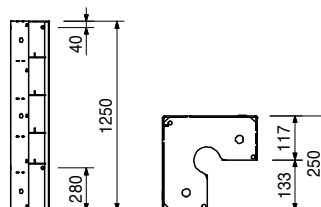
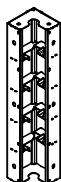

066047	21,300
--------	--------

## Zglobni kutni element DGE 125

Aluminijski element s aluminijskom oplatnom pločom. Za kose kutove od 75° primjenjuje se izvana i iznutra.



## Komplet s

1 kom. 066100 kutni elem. za učvršć. DEA 90°

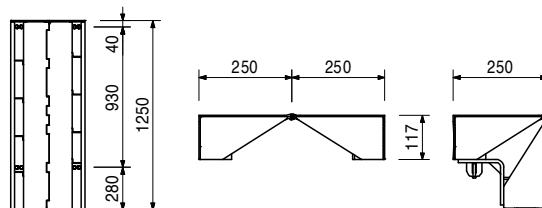

br. art.	težina kg
066048	4,030
101964	5,940

**Elem. za izjednačavanje debljine zida DWD 125**  
**Elem. za izjednač. debljine zida DWD 125 x 5**  
**Elem. za izjednač. debljine zida DWD 125 x 10**  
 Za prilagodbu debljinama zida.

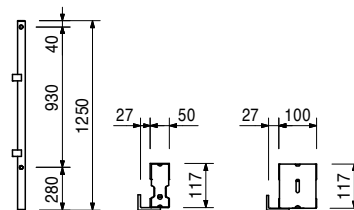

066046	5,490
--------	-------

**Vanjski kutni element DAW 125**  
 Za spoj elemenata na vanjskim kutovima od 90°.

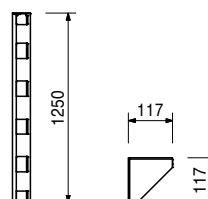

066053	2,070
--------	-------

**Oslonac prilagodne ploče DPA 125**  
 Za izjednačavanje prilagodnom pločom 21 mm.

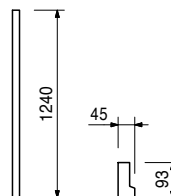

111655	77,100
--------	--------

**Element okna DSE 125**  
 Element za premještanje kompletne unutarnje oplata okna.

**Tehnički podaci**

Dopuštena nosivost točke preuzimanja opterećenja 2,0 t.

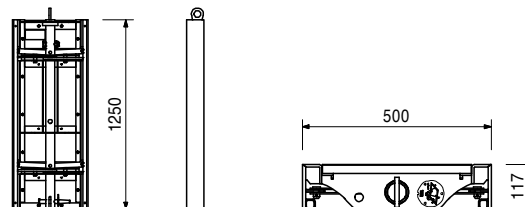
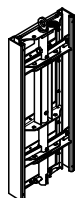

111665	4,360
--------	-------

Pribor  
**Vreteno elementa okna DSE**

# DOMINO 300 okvirna oplata

br. art.	težina kg
101934	8,140
108856	8,980

**Čeoni elementi DOMINO AT 125**  
**Čeoni element DOMINO AT 125 x 3**  
**Čeoni element DOMINO AT 125 x 5**  
 Vanjski dio za čeone oplatae.

**Uputa**  
 Pokrivanje betonom oko 30 odn. 50 mm.

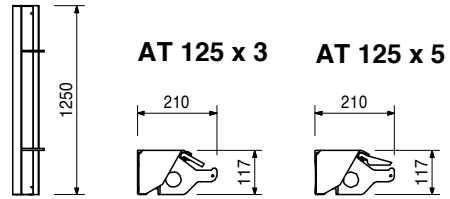

101935	14,600
101936	15,200
101937	17,500
101940	19,300

**Čeoni elementi DOMINO MTF 125**  
**Čeoni element DOMINO MTF 125 x 20**  
**Čeoni element DOMINO MTF 125 x 24/25**  
**Čeoni element DOMINO MTF 125 x 30**  
**Čeoni element DOMINO MTF 125 x 35/36**  
 S osloncem dilatacijske trake za čeone oplatae.

**B**

118  
 158  
 218  
 268

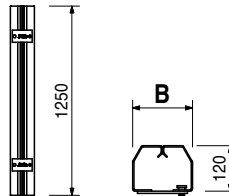

066064	12,100
--------	--------

**Element D 75 x 25**  
 Čelični element s oplatnom pločom 15 mm.

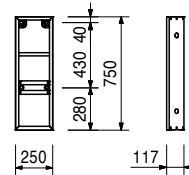

125486	14,500
--------	--------

**Element D 75 x 35**  
 Čelični element s oplatnom pločom 15 mm.

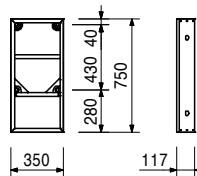

066063	19,300
--------	--------

**Element D 75 x 50**  
 Čelični element s oplatnom pločom 15 mm.

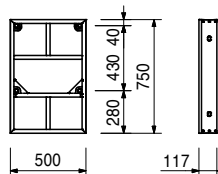

# DOMINO 300 okvirna oplata



br. art.	težina kg
066061	26,500

## Element D 75 x 75

Čelični element s oplatom pločom 15 mm.

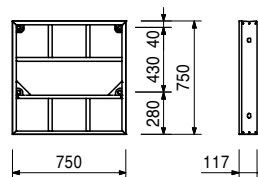
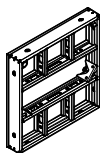

066060	32,400
--------	--------

## Element D 75 x 100

Čelični element s oplatom pločom 15 mm.

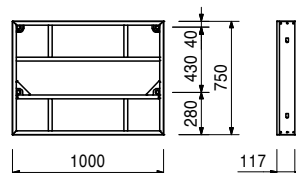
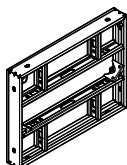

066062	31,600
--------	--------

## Višenamjenski element DM 75 x 75

Čelični element s oplatom pločom 15 mm. Za kose kutove, zidne priključke, čeone oplata itd.

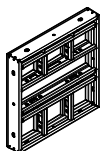

## Komplet s

46 kom. 030290 čepovi Ø 20 mm

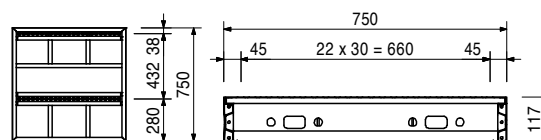

126274	21,000
--------	--------

## Unutarnji čelični kutni element DISE 75

Za unutarnje kutove od 90°.

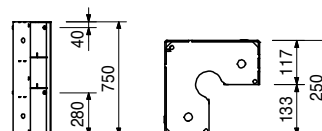
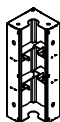

066067	14,200
--------	--------

## Zglobni kutni element DGE 75

Aluminijski element s aluminijskom oplatom pločom. Za kose kutove od 75° primjenjuje se izvana i iznutra.



## Komplet s

1 kom. 066100 kutni elem. za učvršć. DEA 90°

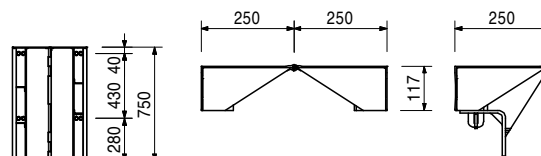

br. art.	težina kg
066068	2,520

**Elem. za izjednač. debljine zida DWD 75 x 5**  
 Za prilagodbu debljinama zida.

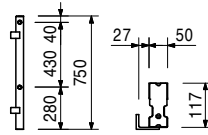

066066	3,500
--------	-------

**Vanjski kutni element DAW 75**  
 Za spoj elemenata na vanjskim kutovima od 90°.

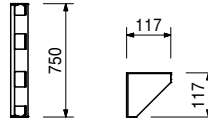

066080	3,940
--------	-------

**Spojница DRS**  
 Za sve DOMINO spojeve elemenata.  
 Izjednačavanja do 12 cm.

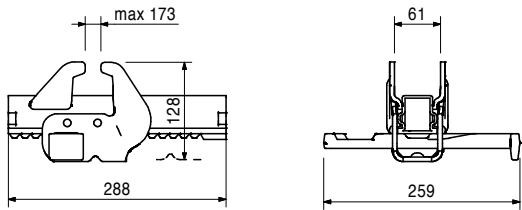
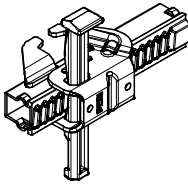

066081	1,160
--------	-------

**Klinasta spojница DKS**  
 Za DOMINO spojeve elemenata bez visokog opterećenja.

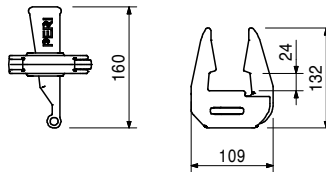
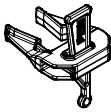

066084	8,510
--------	-------

**Profil za izjednačavanje DAR 80**  
 Za izjednačavanje dužina, nadogradnju, čeonu oplatu i posebne primjene u DOMINO sistemu.  
 Priključni dijelovi ne mogu se izgubiti.

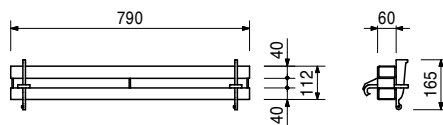
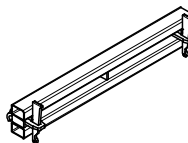



br. art.	težina kg
110406	2,100

## Čeono sidro-2 DSA

Za prijenos sile iz čeonih oplata u DOMINO elemente. Navoj DW 15.

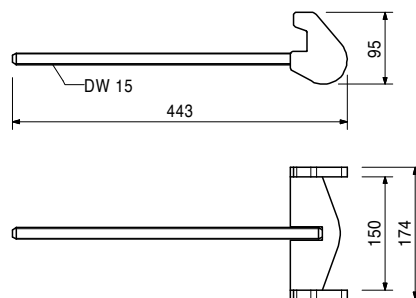
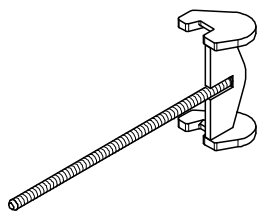

030290	0,002
--------	-------

## Čepovi Ø 20 mm

Za zatvaranje nekorištenih sidrenih otvora Ø 20 mm.

## Uputa

Jedinica isporuke: 500 kom.

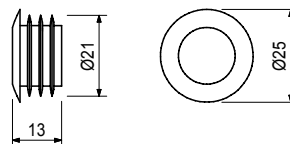

066088	2,030
--------	-------

## Čeona trobridna letvica DSD 250

Za DOMINO oplata stupa i vanjske kutove.

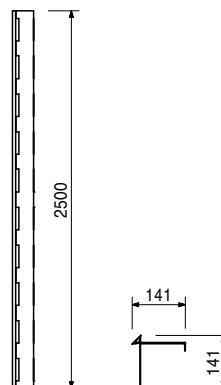

066086	1,110
--------	-------

## Držać sidra DAH, poc.

Za sidrenje izvan okvira neovisno o rasteru, posebice kod temelja.

## Tehnički podaci

Dopuštena vlačna sila sidra:  
otvor 1 = 20 kN  
otvor 2 = 10 kN

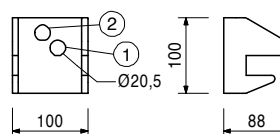
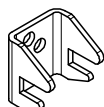

br. art.	težina kg
066100	1,470

## Kutni element za učvršćivanje DEA 90°

Za unutarnje kutove od 90°.

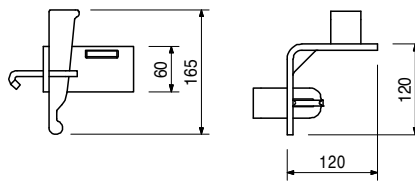
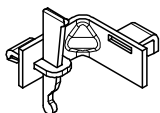

066095	1,060
--------	-------

## Kutni element za učvršćivanje DGE 135° iznutra

Za unutarnje kutove od 135°.

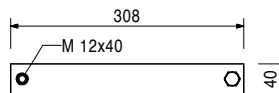
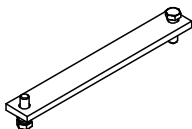

## Komplet s

2 kom. 710224 vijak ISO 4017 M12 x 40-8.8, poc.

066097	1,560
--------	-------

## Kutni element za učvršćivanje DGE 135° izvana

Za vanjske kutove od 135°.

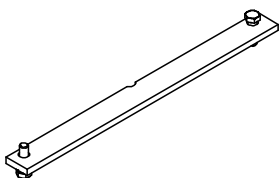

## Komplet s

2 kom. 710224 vijak ISO 4017 M12 x 40-8.8, poc.

111665	4,360
--------	-------

## Vreteno elementa okna DSE

Za primjenu kod elementa okna DSE.  
Za vraćanje vretenom u početni položaj.  
1 komad po elementu okna DSE.

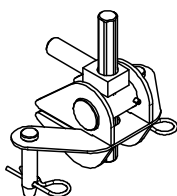

## Komplet s

2 kom. 105822 svornjak Ø 20 x 102, poc.  
2 kom. 022230 osigurač 5/1, poc.

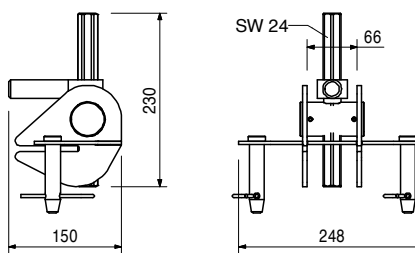

066085	6,970
--------	-------

## Konzola DG 85

Za montažu radne skele i skele za betoniranje u DOMINO oplatomnom sistemu.

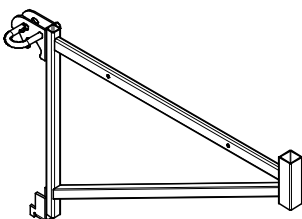

## Tehnički podaci

Dopušteno opterećenje 150 kg/m<sup>2</sup> na maks. utjecajnoj širini od 2,00 m.

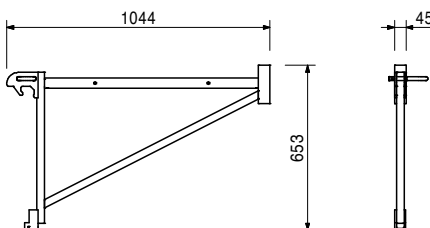

116292	4,730
--------	-------

Pribor

## Stup ograde HSGP-2

# DOMINO 300 okvirna oplata

br. art.	težina kg
106877	2,730

## Držac stupa ograde DOMINO

Za montažu osiguranja od pada na DOMINO elemente.



## Komplet s

1 kom. 018060 osigurač 4/1, poc.

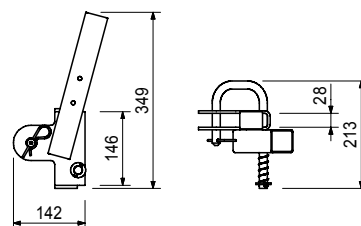

116292	4,730
--------	-------

Pribor

## Stup ograde HSGP-2

116292	4,730
--------	-------

## Stup ograde HSGP-2

Kao osiguranje od pada kod različitih sistema.

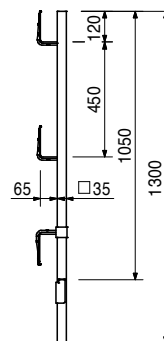

066091	6,330
--------	-------

## Kuka za premještanje DOMINO 500 kg

Za transport DOMINO elemenata.

## Uputa

Voditi računa o uputama za primjenu!

## Tehnički podaci

Dopuštena nosivost 500 kg.

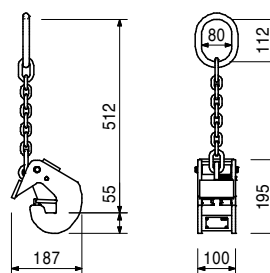

br. art.	težina kg
066094	8,040

### Kutija za slaganje DOMINO DSR, poc.

Za slaganje i transport 2-8 DOMINO elemenata svih veličina. Za transport dizalicom i viličarom. 4 kutije za slaganje DSR po naslazi elemenata.

### Uputa

Voditi računa o uputama za primjenu!

### Tehnički podaci

Dopuštena nosivost: 250 kg po kutiji za slaganje, 1 t po naslazi elemenata.

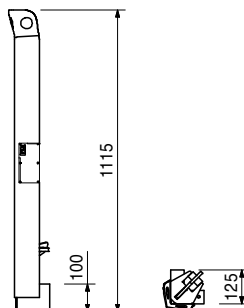
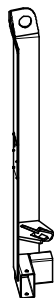

066093	0,020
--------	-------

### Pomoćni element za slaganje DOMINO DSH

Plastika. Sprečava bočno klizanje elemenata.

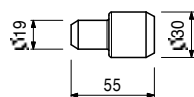

066099	0,030
--------	-------

### Pomoćni kut za slaganje DOMINO DSW

Za slaganje DOMINO elemenata. 4 komada po naslazi elemenata.

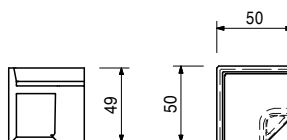
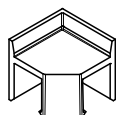

# DOMINO 300 okvirna oplata



br. art.	težina kg
027680	49,600

## Priključna šina SB-1, 2 - MX/TR/D

Za montažu okvirnih podupirača SB-1, 2 na MAXIMO, TRIO i DOMINO elementima.

## Tehnički podaci

Dopuštena nosivost točke preuzimanja opterećenja 1,0 t pri ovisnom nagibnom kutu  $\leq 15^\circ$ .

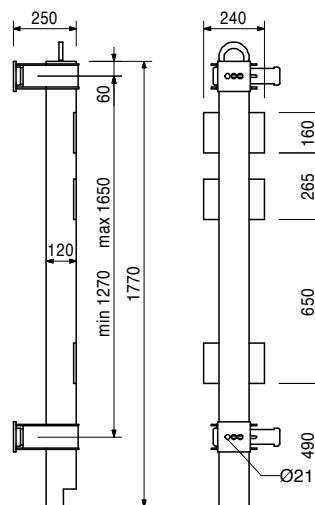
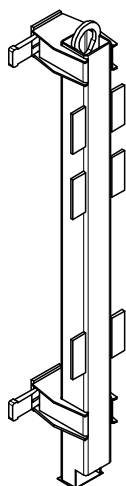

027690	0,368
027590	2,400
113255	0,414
114107	1,190
114417	1,400

Pribor

**Svornjak SB-TRIO/DOMINO, poc.**

**Kukasta spojnica SB-1,2**

**Svornjak SB-MAXIMO, poc.**

**Čahura SB-MAXIMO, poc.**

**Čahura SB-MAXIMO WDMX**

025740	9,140
--------	-------

## Priključak SB-A, B, C - MX/TR/D

Za spoj MAXIMO, TRIO i DOMINO elemenata s okvirnim podupiračem jednostrane oplate SB-A0, A, B, C.

## Uputa

1 komad po sidrenoj poziciji.

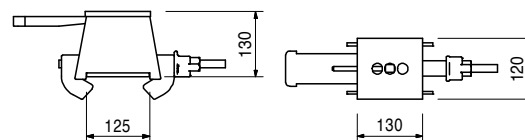
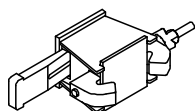

027690	0,368
113255	0,414
114107	1,190
114417	1,400

Pribor

**Svornjak SB-TRIO/DOMINO, poc.**

**Svornjak SB-MAXIMO, poc.**

**Čahura SB-MAXIMO, poc.**

**Čahura SB-MAXIMO WDMX**

027690	0,368
--------	-------

## Svornjak SB-TRIO/DOMINO, poc.

Za okvirne oplate konstrukcijske visine 12 cm.

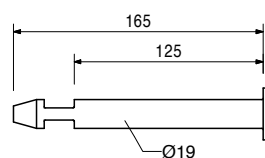
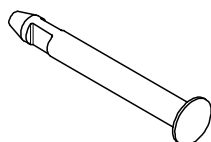

114107	1,190
114417	1,400

Pribor

**Čahura SB-MAXIMO, poc.**

**Čahura SB-MAXIMO WDMX**

br. art.	težina kg
066090	2,480

## Stezač perforirane trake DOMINO DLS

Za sidrenje oplata temelja u kombinaciji s perforiranom trakom.

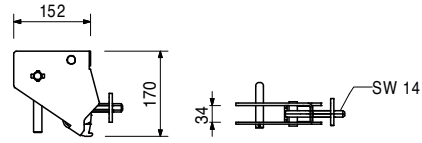
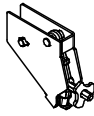

023020	0,676
--------	-------

## Perforirana traka, rola 25 m

Za primjenu sa stezačem perforirane trake TRIO, DOMINO i HANDSET.

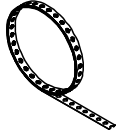

## Tehnički podaci

Dopuštena vlačna sila 12,9 kN.

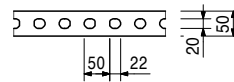

066082	1,040
--------	-------

## Priključak kosnika DRA

Za priključak kosnika i stabilizatora na DOMINO element.

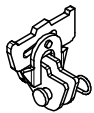

## Komplet s

1 kom. 027170 svornjak Ø 16 x 42, poc.

1 kom. 018060 osigurač 4/1, poc.

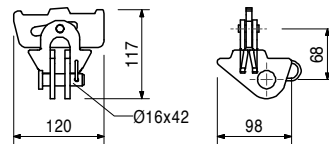

117466	10,600
--------	--------

## Kosnik RS 210, poc.

Dužina izvlačenja L = 1,30 - 2,10 m.  
Za centriranje PERI oplatah sistema i komponenti.

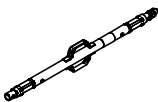

## Uputa

Dopušteno opterećenje vidi u PERI tablicama.

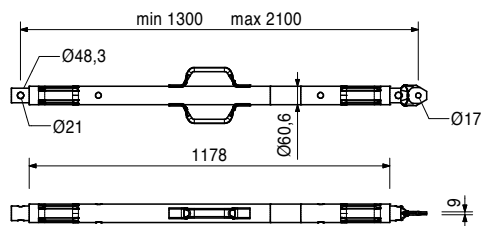

118238	12,200
--------	--------

## Kosnik RS 260, poc.

Dužina izvlačenja L = 2,30 - 2,60 m.  
Za centriranje PERI oplatah sistema i komponenti.

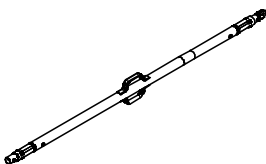

## Uputa

Dopušteno opterećenje vidi u PERI tablicama.

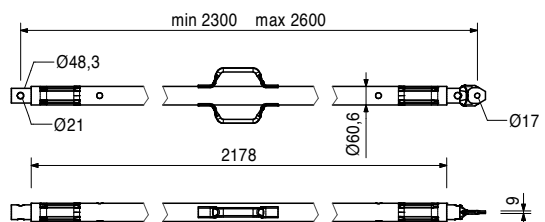

# DOMINO 300 okvirna oplata



br. art.	težina kg
117467	15,500

## Kosnik RS 300, poc.

Dužina izvlačenja L = 1,90 - 3,00 m.  
Za centriranje PERI oplatnih sistema i komponenti.

## Uputa

Dopušteno opterećenje vidi u PERI tablicama.

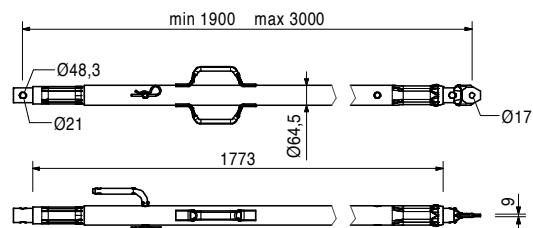
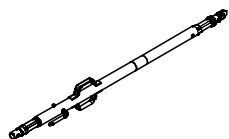

117468	23,000
--------	--------

## Kosnik RS 450, poc.

Dužina izvlačenja L = 2,80 - 4,50 m.  
Za centriranje PERI oplatnih sistema i komponenti.

## Uputa

Dopušteno opterećenje vidi u PERI tablicama.

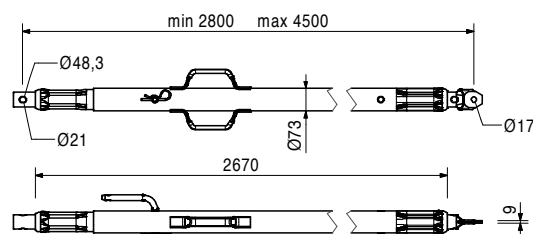
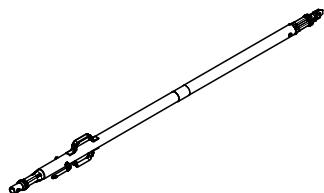

117469	40,000
--------	--------

## Kosnik RS 650, poc.

Dužina izvlačenja L = 4,30 - 6,50 m.  
Za centriranje PERI oplatnih sistema i komponenti.

## Uputa

Dopušteno opterećenje vidi u PERI tablicama.

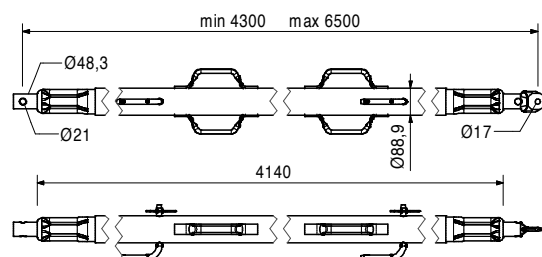
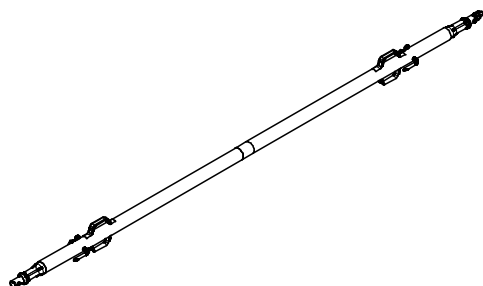

028990	115,000
--------	---------

## Kosnik RS 1000, poc.

Dužina izvlačenja L = 6,40 - 10,00 m.  
Za centriranje PERI oplatnih sistema.

## Uputa

Dopušteno opterećenje vidi u PERI tablicama.

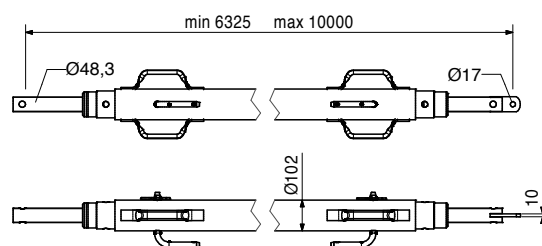
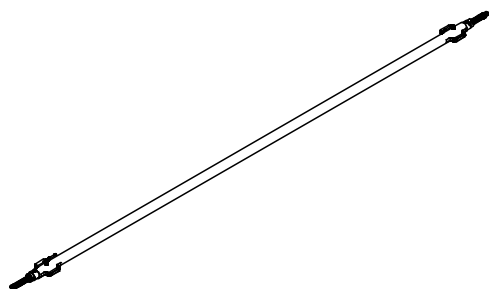

# DOMINO 300 okvirna oplata



br. art.	težina kg
103800	271,000

## Kosnik RS 1400, poc.

Dužina izvlačenja L = 6,40 - 14,00 m.  
Za centriranje PERI oplatnih sistema.

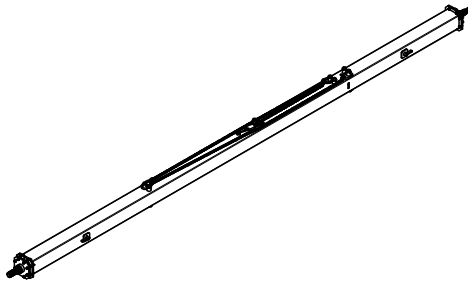

## Uputa

Dopušteno opterećenje vidi u PERI tablicama.  
Lancem se rukuje s tla.

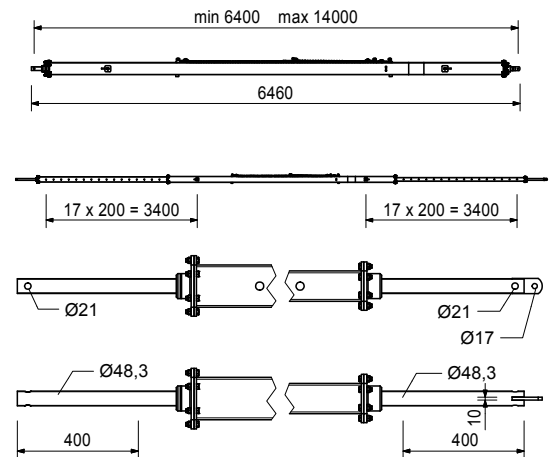

117343	3,250
--------	-------

## Podnožje-2 za RS 210 – 1400, poc.

Za montažu kosnika RS 210, 260, 300, 450, 650, 1000 i 1400.

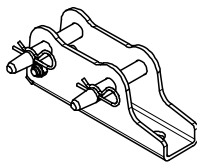

## Komplet s

2 kom. 105400 svornjak Ø 20 x 140, poc.  
2 kom. 018060 osigurač 4/1, poc.

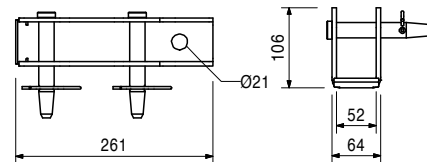

124777	0,210
--------	-------

Pribor

## Sidreni vijak PERI 14/20 x 130

028010	17,900
--------	--------

## Kosnik RSS I

Dužina izvlačenja L = 2,05 - 2,94 m.  
Za centriranje PERI oplatnih sistema.

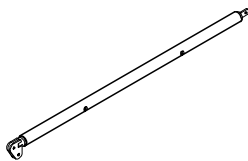

## Uputa

Dopušteno opterećenje vidi u PERI tablicama.

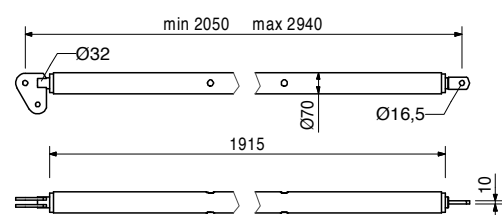



# DOMINO 300 okvirna oplata



br. art.	težina kg
028020	22,000

## Kosnik RSS II

Dužina izvlačenja L = 2,91 - 3,80 m.  
Za centriranje PERI oplatah sistema.

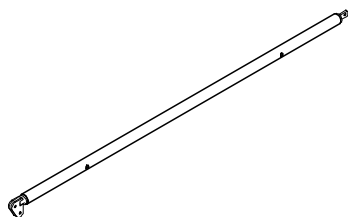

## Uputa

Dopušteno opterećenje vidi u PERI tablicama.

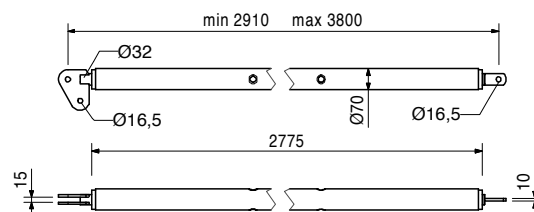

028030	38,400
--------	--------

## Kosnik RSS III

Dužina izvlačenja L = 4,60 - 6,00 m.  
Za centriranje PERI oplatah sistema.

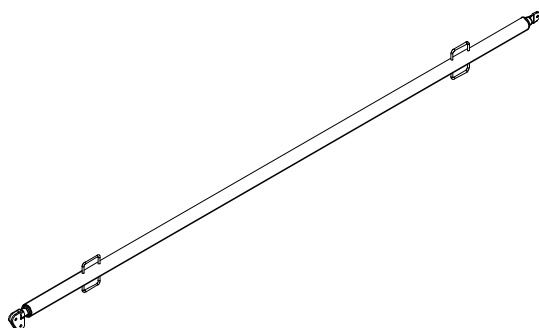

## Uputa

Dopušteno opterećenje vidi u PERI tablicama.

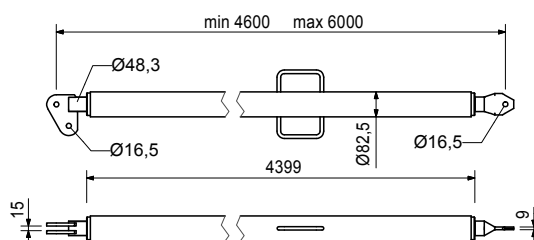

106000	1,820
--------	-------

## Podnožje-2 za RSS, poc.

Za montažu kosnika RSS.

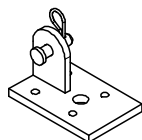

## Komplet s

1 kom. 027170 svornjak Ø 16 x 42, poc.  
1 kom. 018060 osigurač 4/1, poc.

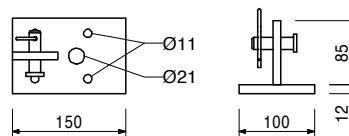

124777	0,210
--------	-------

Pribor

## Sidreni vijak PERI 14/20 x 130

# DOMINO 300 okvirna oplata



br. art.	težina kg
057087	3,720
057088	4,410

**Stabilizatori AV**  
**Stabilizator AV 82**  
**Stabilizator AV 111**  
 Za centriranje PERI oplatah sistema.

min. L	maks. L
500	820
790	1110

**Komplet s**  
 1 kom. 027170 svornjak Ø 16 x 42, poc.  
 1 kom. 018060 osigurač 4/1, poc.

**Uputa**  
 Dopušteno opterećenje vidi u PERI tablicama.

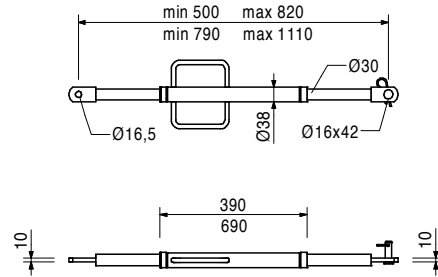
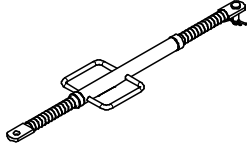

028110 5,180

**Stabilizator AV 140**  
 Dužina izvlačenja L = 1,08 - 1,40 m.  
 Za centriranje PERI oplatah sistema.

**Komplet s**  
 1 kom. 027170 svornjak Ø 16 x 42, poc.  
 1 kom. 018060 osigurač 4/1, poc.

**Uputa**  
 Dopušteno opterećenje vidi u PERI tablicama.

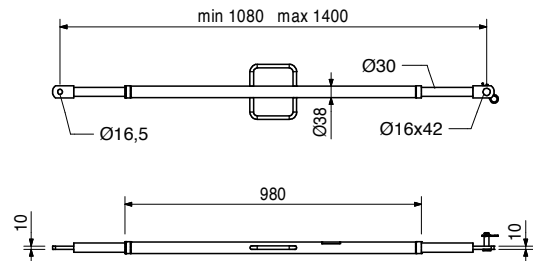
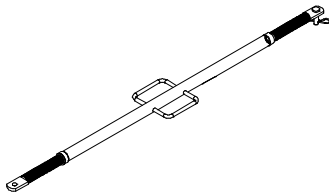

108135 12,900

**Stabilizator AV 210**  
 Dužina izvlačenja L = 1,28 - 2,10 m.  
 Za centriranje PERI oplatah sistema.

**Komplet s**  
 1 kom. 027170 svornjak Ø 16 x 42, poc.  
 1 kom. 018060 osigurač 4/1, poc.

**Uputa**  
 Dopušteno opterećenje vidi u PERI tablicama.

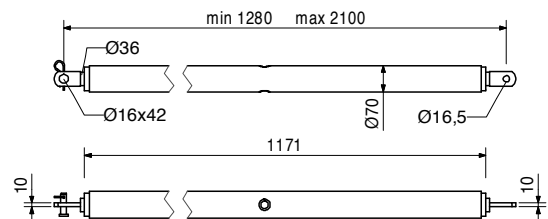
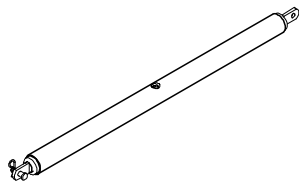

br. art.	težina kg
028120	17,000

## Stabilizator AV RSS III

Dužina izvlačenja L = 2,03 - 2,92 m.  
Za centriranje PERI oplatah sistema.

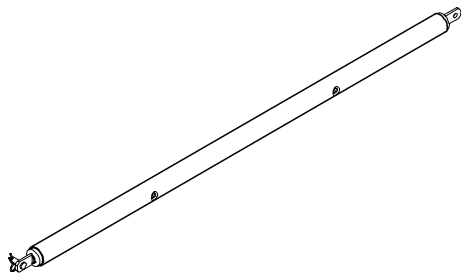

## Komplet s

1 kom. 027170 svornjak Ø 16 x 42, poc.  
1 kom. 018060 osigurač 4/1, poc.

## Uputa

Dopušteno opterećenje vidi u PERI tablicama.

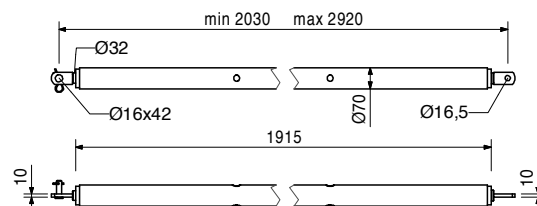

124777	0,210
--------	-------

## Sidreni vijak PERI 14/20 x 130

Za privremeno učvršćivanje na armiranobetonskim komponentama.

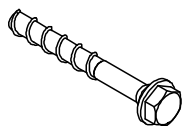

## Uputa

Voditi računa o PERI tehničkim specifikacijama!  
Otvor za bušenje Ø 14 mm.

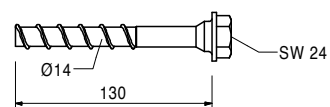

**Optimalan sistem  
za svaki projekt  
i svaki zahtjev**



**Zidne oplaste**



**Oplaste stupa**



**Stropne oplaste**



**Penjaјуći sistemi**



**Oplaste za mostove**



**Oplaste za tunele**



**Nosive skele**



**Građevinske radne skele**



**Fasadne radne skele**



**Industrijske radne skele**



**Stepeništa**



**Zaštitne skele**



**Sigurnosni sistemi**



**Pribor neovisan o sistemima**



**Usluge**



**PERI oplaste i skele d.o.o.**  
**Oplaste Skele Inženjering**  
Banjavčičeva 13  
10000 Zagreb  
Hrvatska  
Tel +385 (0)1.655 36 36  
Faks +385 (0)1.655 36 37  
info@peri.com.hr  
www.peri.com.hr

